

**Amira Elnokaly**, PhD in Architectural Engineering Lecturer, Architectural Engineering and Environmental Design Dept., AAST,  
*amira.elnokaly@aast.edu*

**Ahmed Elseragy**, PhD in Architectural Engineering, Lecturer,  
Architectural Engineering and Environmental Design Dept., AAST,  
*ahmed.elseragy@aast.edu*

## Revitalisation of Traditional Curved Roofs for Indoor Thermal Comfort in Hot Climates

### ABSTRACT

Traditional passive cooling techniques in hot arid regions have been discussed in previous research work to explore their passive-cooling abilities and strategies. This paper dwells on traditional curved-roof geometries and forms in order to create more energy efficient buildings and indoor thermal comfort environments in hot climates.

This paper presents part of a continuing research, which is aimed at exploring the relationship between the intensity of the received solar radiation on roofs and their geometrical configurations. Throughout the research, a number of investigations have been carried out on different curved-roofs forms (domes and vaults) with different curvatures (cross section ratios (CSR)) at different orientations to study their solar radiation performance. This paper illustrates some of the generated results which compare between the Hourly Total Clear Sky Irradiance Intensity  $I_{HTCS}$  W/m<sup>2</sup> on flat and vaulted-roof, which has a semicircular Vaulted-roof Cross-sections Ratio,  $VSCR = 1$ . The geographical latitude of Aswan (23.58°N) has been chosen to represent the hot dry climatic conditions of southern Egypt.

## **Introduction**

All through history, people were trying to adapt their dwellings with the environment in order to create more suitable living conditions. Traditionally, dwellings and other buildings have been constructed with full respect to the characteristics of a particular geographical location in order to control its local climatic conditions. Consequently, different types of architecture have arisen to adapt different climatic and cultural conditions, which vary from region to region. Traditional and vernacular buildings showed real sustainability through employing native construction materials and techniques, which efficiently enabled them to minimize their negative environmental impacts, reduce the energy required to supply different climatic controllers and provide indoor thermal comfort.

In developing countries, despite the global shortage of non-renewable energy sources and the increasing environmental pollution problems, half of the global energy consumption still occurs in buildings. Increasingly in Egypt and other developing hot-arid regions, the concern is to establish systems, which make use of Natural Passive Cooling more efficiently than in the past, and to ensure sustainability of resources. This is particularly obvious in buildings constructed in locations with extreme hot climatic conditions, where the difference between unbearable outdoor and desirable indoor climatic conditions is large. Yet many developing countries' buildings in harsh desert climates neither reflect their local climatic conditions nor architectural identity.

On the other hand, many years ago and prior to the introduction of modern air-conditioning systems, traditional towns and cities of the Arab Countries (Middle East, North Africa, and Arabian Peninsula) started to lose their regional characteristics and embody modern forms and shapes. Their traditional architecture and buildings made use of many available resources to provide passive indoor thermal comfort. Moreover, contemporary buildings are becoming increasingly complex; involving technologically advanced building materials, and mechanical systems for controlling interior air quality, thermal comfort, lighting and acoustics. Furthermore, these systems, which rely exclusively on

utilisation of non-renewable energy, are often expensive and environmental pollutants. Buildings' envelopes and roofs have a major influence on thermal indoor conditions. In addition to a number of climatic and physical factors, indoors-thermal comfort depends significantly on the reduction of energy input that the intensity of solar irradiance above roofs causes in hot climates <sup>[1]</sup>.

The roof is the only continuously exposed element of the building's envelope; it receives great amount of solar radiation, which is the main cause of heat gain and indoor thermal discomfort in the summer of hot-arid climates. About 50% of the heat load in buildings is from the roof, because it is the element most exposed to the sky. In this context, the paper aims to investigate the solar performance of vaulted and domed roofs in comparison to a flat roof.

### **Geometrical Resemblance of Vaulted Roof**

For vaulted-roofs, the proposed geometrical resemblance methodology in this paper is neither new nor only employed in this research work. Customary in CAD tools, most of curvy forms have been geometrically resembled by group of planar segments, pixels, or stripes. This technique is employed in most two and three-dimensional CAD drawings, Fig. (2). Sensibly, and regardless to the tested curvy form nature, the more resembling planar segments or pixels the more accurate results will be. Fig. (3) shows a semisrcular vaulted-roof-cross section (VCS), which has been geometrically resembled by two types of planar segments. This simplifies the calculations of solar radiation intensity on vaulted-roof outer surfaces. Fig (4) shows the geometrical resemblance of a semicircular vaulted-roof cross section (VCS). Nineteen joint segments have geometrically resembled the vaulted roof VCS. In addition to the horizontal segment at the middle-top of the curve<sup>1</sup>, each half-VCS has been divided into nine joint segments <sup>[4]</sup>.

---

<sup>1</sup> Any VCS curvature can be also resembled by 37 Segments instead of 19 Planar Joint-Segments or by tangent planar segments [7]

## Simulation Design And Tools

*Solar Radiation Simulation Model (SRSM)* is a computer algorithm, which is developed by Professor R. H. B. Exell, 1999, King Mongkut's University of Technology Thonburi. The parametrical study in this paper is mainly based on the *SRSM* <sup>[5],[6]</sup>. It can be generally applied for the calculation of direct, diffuse, and ground reflected hourly irradiance on a surface at any orientation and slope according to the selected parameters and data inputs. In general, the calculations methodology depends on computing the received  $I_{(HTCS)}$  on each tilted planar segment by the *SRSM*, then calculating the average of the received  $I_{(HTCS)}$  on group of planar segments, which resemble either full VCS or a particular sector of a vaulted-roof. The hourly clear sky irradiance intensity  $I_{(HTCS)}$  on the full VCS can be determined by calculating the average of the received  $I_{(HTCS)}$  on number of planar segments along the VCS, equation (1). Roof surface has to be defined geometrically in term of angles that determine both surface slope angle and azimuth angle (*orientation or the direction that the surface faces*) <sup>[7]</sup>.

$$I_{(HTCS)} = \frac{\sum (I_{(HTCS)} \text{ : } I_{(HTCS)} \text{ 19})}{37} \quad (1) \text{ [7]}$$

The calculated average of the received  $I_{(HTCS)}$  on full VCS or on selected part is valid and appropriate to compare between intensities ( $\text{W/m}^2$ ) on different forms. While, for the calculations of the received  $I_{(HTCS)}$  on an entire surface area of a form, the resulted average intensity  $\text{W/m}^2$  has to be multiplied by this area ( $\text{m}^2$ ). On the other hand, to compare between the total solar radiation intensities fall on two surface areas of two different forms, the surface areas have to be equal. In the case of different surface areas, the intensity  $\text{W/m}^2$  has to be multiplied by a factor that represents the surface areas ratio.

## Discussion and Results Analysis

*SRSM* has been used to calculate the received I(HTCS) on different roof geometries in order to examine the solar radiation intensity above roof outer-surfaces compared to the flat roof. All roof geometries calculations have been carried out at two principal and two secondary facing directions in both summer and winter. Fig (5) shows the vaulted-form orientation (curvature-facing-direction), (N-S), (E-W), (NE-SW), and (NW-SE) <sup>[4]</sup>. This paper discusses the N-S curvature-facing-orientation only.

In the case of vaulted-roof curvature faces the north and the south, the longitudinal axis of the vaulted-roof (perpendicular on the VCS) is the East-West axis. The two halves of VCS face northward and southward. Fig (6) shows the I(HTSC) on flat and vaulted-roof facing NS during summer and winter. The maximum received solar radiation in both roofs take place at midday. At summer, I(HTSC)-curves (I(HTCS)-values distribution forms) at both tested geometries Both vaulted roof and flat roof have similar characteristics. Each roof I(HTSC)- curve ascends differently after 6:00 in the morning where both I(HTSC)-curves are still encountered. They reach their maximum at 12:00. During the afternoon solar radiation intensity on both roofs geometries descend differently till the two curves encounter each other again at 18:00, Fig. (6).

At 6:00 and 18:00 both vault and flat roof receive approximately equal I(HTSC)-values, 104 W/m<sup>2</sup> and 106W/m<sup>2</sup> respectively. The minimum difference between the two I(HTSC)-curves has been recorded at the early-morning and the late-afternoon. It slightly increases till it reaches the maximum at 12:00 (1070 – 683 = 387 W/m<sup>2</sup>). I(HTSC)-curve for flat roof starts and ends with steeper gradients comparatively to vaulted-roof ones, then it gets smoother around 12:00 at both roofs geometries. Identical to the previous scenario in summer, the maximum received solar radiation intensity in winter takes place at 12:00. Moreover, in winter both geometries vaulted-roof and flat roof have similar characteristics of I(HTSC)-curves.

On the contrary to what has been observed in summer, the noticeable difference has been shifted 2 hours (from 7:00 & 17:00 in summer to 9:00 & 15:00 in winter). As shown previously in the same figure, the difference between the two geometries I(HTCS)-curves records its minimum at the early-morning and the late-afternoon hours. It increases and reaches the maximum at 12:00 ( $740 - 576 = 164 \text{ W/m}^2$ ). Fig. (6) also shows that during the early-morning and the late-afternoon hours vaulted-roof and flat roof receive very close I(HTCS)-values (nearly equal), which is dissimilar to (N-S) orientation in summer. This could be even better during winter in which there is no need to reduce the received solar radiation intensity above roofs outer surfaces.

## Conclusions

*SRSM* produced valuable predictions with accurate procedures calculating the total clear sky intensity of solar radiation on the semicircular vaulted-roof, in which VCSR always equals 1 ( $A = B$ ). At the same geographical latitude, *SRSM* results showed that the ratio between the received solar radiation amount  $\text{W/m}^2$  by flat roof differs significantly from that received by sloped surfaces which resemble the form of a vaulted-roof. By testing the same VCSR at different orientations, the parametrical study and SMSR highlighted the magnitude of VCS orientation to control the received solar radiation intensity. It has been noticed that the calculated solar radiation intensity on one planar segment varies significantly if either its slope angle or orientation has been slightly changed, also see reference <sup>[8]</sup>.

At north-south facing curvature, solar radiation readings, I(HTCS)-values, and consequently the resulted-difference due to the geometrical configurations are exactly identical around the midday axis. I(HTCS)-curves for any geometry are exactly symmetrical around the midday axis. In both summer and winter, regardless to the roof geometry, I(HTCS)-peaks are recorded at midday. Despite of testing only one curvature (invariable VCSR in this paper), it has been concluded that the generated drops in the I(HTCS) values and distribution forms on the two tested roofs keep varying from case to another due to VCS orientation and seasonal variation. But it is clearly noticed that

I(HTCS)-curves and their shapes are always symmetrical around midday axis. Moreover, regardless of roof forms and relevant to the sun position at 12:00 in summer, which is almost perpendicular to geographical latitudes near the equator (23.58oN) both principal-orientations generated identical I(HTCS)-values during midday.

On the other hand, in winter and due to the low position of the sun comparatively to summer, which means that the orientation is effectible as long as the tested geometry is not a flat roof. On the daily-average bases (N-S)-facing-orientation seems to be more energy-efficient in terms of making the vaulted-roof receives 66.3% from that received on flat roof. Whereas, vaulted-roof receives 75.4% from that has been received by the flat roof.

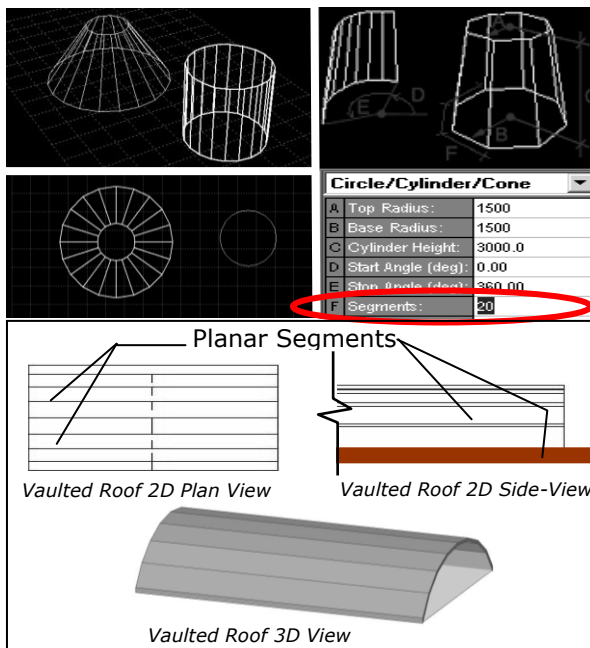
Roof Geometry	Day Average $I_{(HTCS)}$ $W/m^2$		$\frac{I_{(HTCS)} VCS}{I_{(HTCS)} flat} \%$	
	June	Dec.	June	Dec.
Flat- Roof	659	365		
N-S Facing Vaulted-roof	437	304	65.85	83.28

**Table 1: Summer & Winter  $I_{(HTCS)}$  % (VCS / Flat)**

## Figures and Graphics

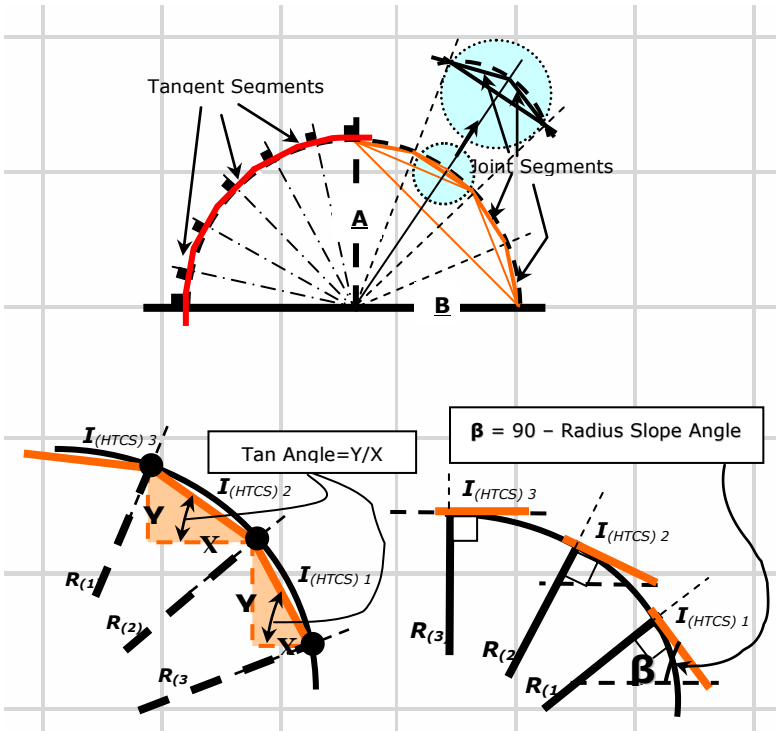


**Figure 1:** Traditional Curved Roofs and Contemporary Architecture [2]

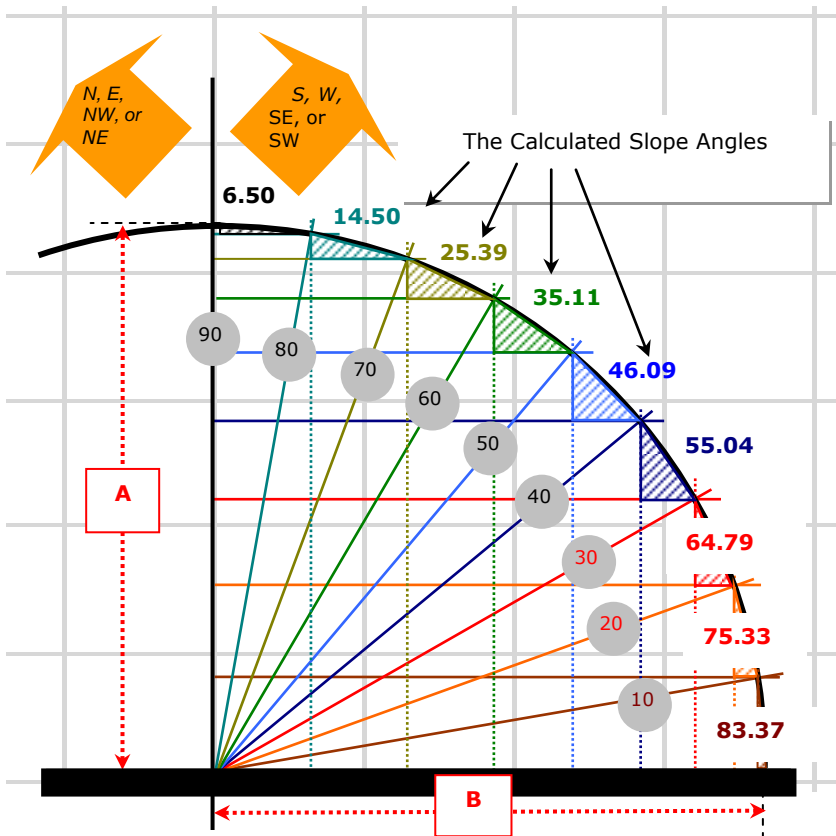


**Figure 2:** CAD Drawings for Curved Forms [3]

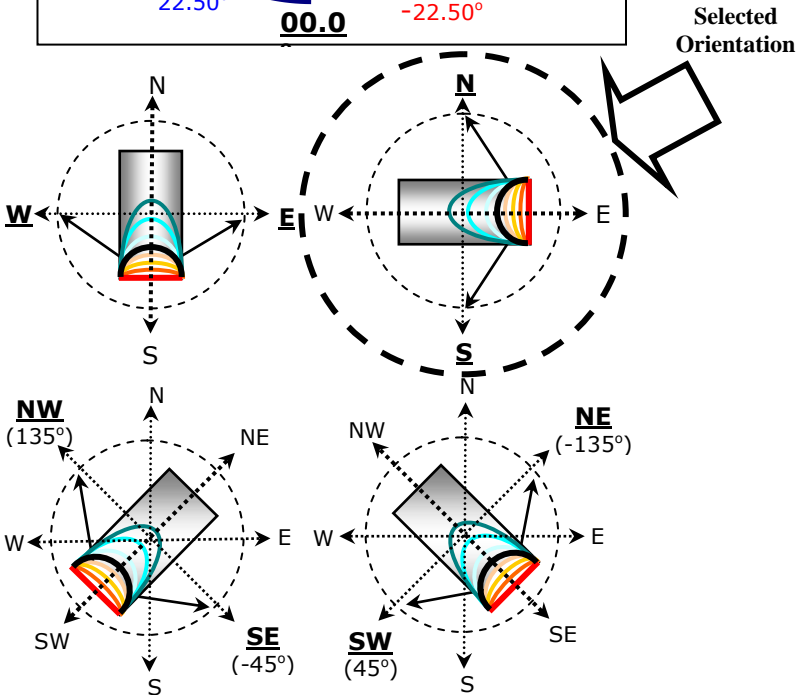
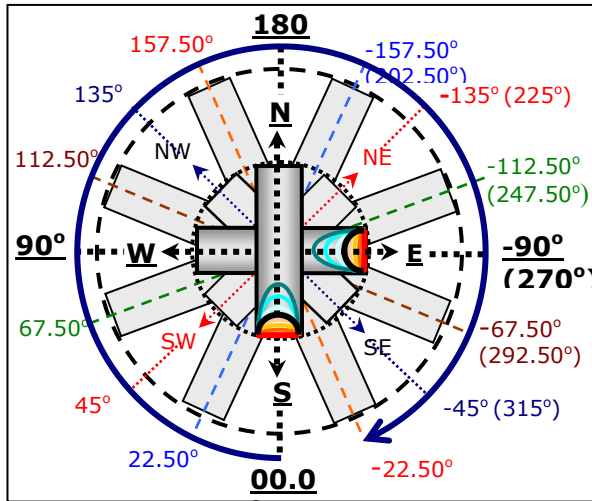




**Figure 3:** The Two-Proposed Planar Segments Techniques and Their Slope Angles Calculations



**Figure 4:** VCS Geometrical Resemblance and Slope Angles of Vaulted-roof Planar Joint Segments <sup>[4]</sup>



**Figure 5:** Vaulted-roof Orientations (*VCS Curvature Faces Principle and Secondary Directions*)

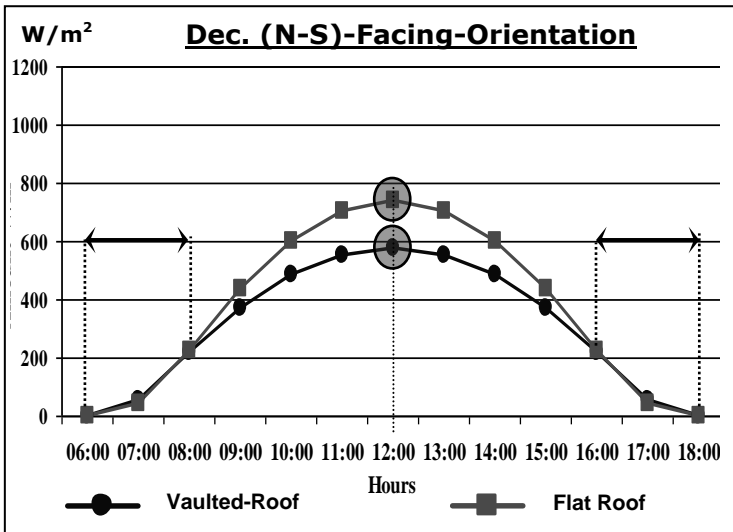
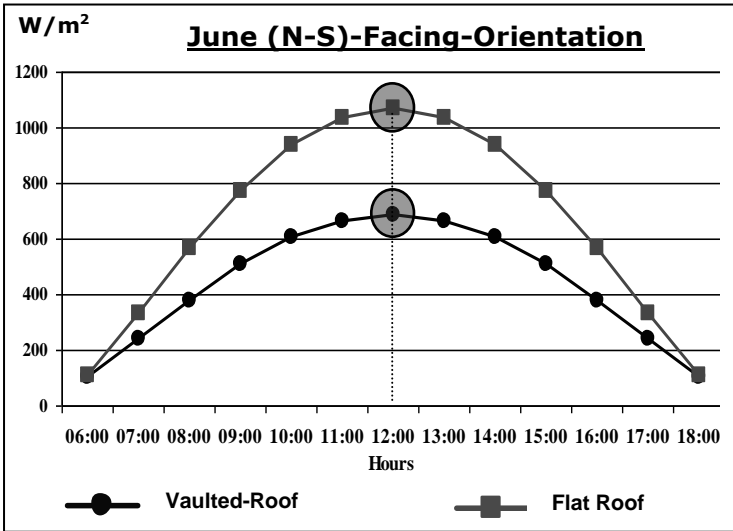


Figure 6:  $I_{(HTCS)}$  (W/m<sup>2</sup>) on Flat Roof and VCS Faces N-S in Summer and Winter

## Notes and References

- [1] Laouadi A. & Atif M. R., Prediction models of optical characteristics for domed skylights under Standard and Real Sky Conditions, Institute of Research in Construction, National Research Council Canada, NRC-CNRC, 7th International IBPS Conference Rio de Janeiro, Brazil, August 13-15, 2001.
- [2] Archnet Digital Library. Internet WWW Page at: [www.archnet.org](http://www.archnet.org)
- [3] ECOTECT v5.0. Interent WWW Page at: <http://www.squ1.com>
- [4] Elseragy, A. A.; Gadi, M. B. Computer Simulation of Solar Radiation Received by Curved Roof in Hot-Arid Regions Proceedings of the Building Simulation 2003 2003 Aug 11-2003 Aug 14; EINDHOVEN, Netherlands.
- [5] SRSM Solar Radiation Simulation Model for Quick Basic, Excell, R. H. B. Regional Energy Resources Information Centre, Asian Institute of Technology, Bangkok.
- [6] Excell R. H. B. A Program in BASIC for Calculating Solar Radiation in Tropical Climates on Small Computers. Renewable Energy Review Journal, 1986 Dec; Vol. 8 (No. 2).
- [7] Elseragy, A. & Gadi, M. B. Roof Geometric Forms and Solar Irradiation Intensity In Hot-Arid Climates Proceeding of the ISES Solar World Congress 2003, ISES 2003, Solar Energy for a Sustainable Future 14-19 June 2003; Svenska Mässan Congress Centre, Göteborg, Sweden.
- [8] Duffie, J. and Beckman W., (1980) Solar Engineering of Thermal Processes.